

FILTER GRILLES

TUTTLE & BAILEY Model CRE500FBLT - Aluminum Eggcrate Filter Grille, T-Bar Lay-In

Neck Size	CFM Range	Price Each
*20x20	800 -1500	\$61

*Filter Not Included

Notes:

- 1/2 x 1/2 x 1/2 eggcrate face
- Flush, hinged face
- Equipped w/ filter retainers
- Accepts 1" x 20" x 20" nominal filter (by others)
- Fits T-bar lay-in

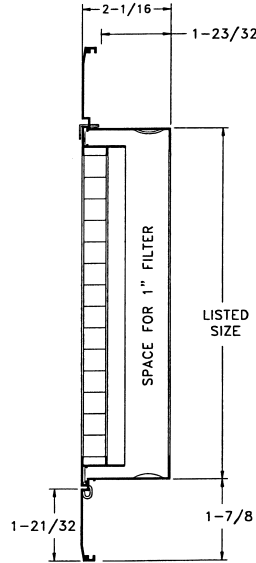

FINISH: White

TUTTLE & BAILEY Model T70DFBLT - Steel, Fixed Bar, Filter Grille, T-Bar Lay-In

Neck Size	CFM Range	Price Each
*20x20	600 -1500	\$52

*Filter Not Included

Notes:

- All steel construction
- Flush, removable face with concealed latches and hinges
- Face can be installed in any direction
- 3/4" spaced bars at 35 degrees
- Fits (standard 15/16) 2' x 2' T-bar ceiling systems
- Equipped with filter retainers
- Accepts 1" x 20" x 20" nominal filter (by others)
- It is recommended that grilles installed in grid ceiling systems be supported independent of the ceiling hardware

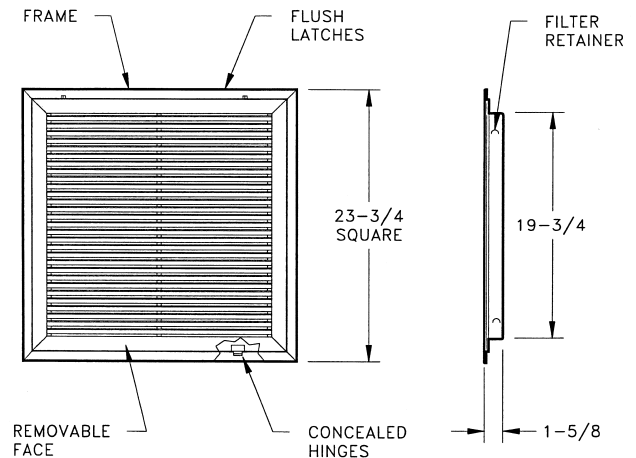

FINISH: White