

FAN POWERED VAV TERMINALS

REDD-I Model NRFHE - Fan-powered VAV terminal

Parallel, intermittent fan-powered, VAV terminal unit provided with the following features:

- ETL label with electric heat options
- Permanent split capacitor motors with thermal overload protection
- Two-sided access for easy access to motor and blower
- 1" fiberglass insulation with 4# density core meeting NFPA-90A requirements

All units are provided with:

- 277V blower motors with Speed Control, Size 500, Size 750 and Size 1500
- Electric Heat: Size 500 Heater is 277v/1 phase, and Size 750 & 1500 Heater is 480v/3 phase.
- Single point power connection, non-fused, door interlock disconnect.
- 75 VA transformer, multi-step magnetic contractors and fan/heater relay with pilot relay.
- Primary valve with Flow-cross velocity sensor.

NRFHE Model Size	Fan CFM Range @ 0.2 ESP	Blower HP@ 277V	Primary Valve (MVA) Size	Primary Valve CFM Range	Electric Heat KW	Heater Stages (Note 1)	Unit MCA	NRFHE Complete Unit Price	NRFHE Freight Surcharge	Model MV Primary Valve ONLY Price
500	250-640	1/6	6	150-510	2.5 & 5	1 or 2	23.8	\$644	\$42	\$76
			8	300-905	2.5 & 5	1 or 2	23.8	631	42	84
			10	600-1415	2.5 & 5	1 or 2	23.8	669	42	91
750	440-1200	1/4	8	300-905	3.5, 7 & 10.5	1, 2 or 3	19.9	769	42	84
			10	600-1415	3.5, 7 & 10.5	1, 2 or 3	19.9	772	42	91
			12	800-2040	3.5, 7 & 10.5	1, 2 or 3	19.9	779	42	99
1500	750-1500	1/2	12	800-2040	3.5, 7 & 10.5	1, 2 or 3	19.9	811	42	99
			14	1000-2780	3.5, 7 & 10.5	1, 2, or 3	19.9	822	42	119

Notes:

1) Heat KW changes are made by combing Stages on the Control Terminal Strip.

Model 500, 2.5 KW Heat is (1) stage only, 5KW may be (1) or (2) stage.
 Model 750 & 1500; 3.5 KW Heat is (1) stage only, 7KW Heat may be (1) or (2) stages and 10.5 KW may be (1), (2), or (3) stages.

2) Model MV rectangular outlet adapter dimensions are available upon request.

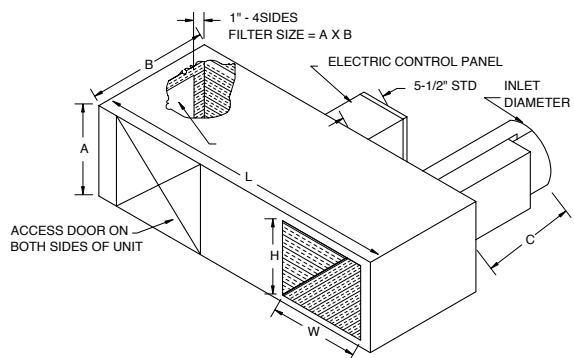

DIMENSIONS

NRFH MODEL SIZE	A	B	C	L	DISCHARGE	
					W	H
500-06	14	18	17	53	14	10
500-08			17		10	
500-10			19		12	
750-08	18	18	17	63	14	14
750-10			19			
750-12			19			
1500-12						
1500-14						

ACCESSORIES

Model	Description	Price Each
CP-133	Pneumatic Control	\$214
CTC-1611	D.A. Pneumatic Wall T-Stat	84
CTR-116	3 Stage Heat w/T-Stat	505
	PE Switch	24