

CEILING RADIATION DAMPERS

ARROW Ceiling Radiation Dampers

Model **AC** - Round

Model **AB** - Square & Rectangular

Model	Size W x H	Price Each
AC	6"	\$16
	8"	19
	10"	21
	12"	26
	14	29
	16	33
AB	6 x 6	\$20
	8 x 8	20
	9 x 9	23
	10 x 10	23
	10 x 22	36
	12 x 12	26
	12 x 24	36
	15 x 15	36
	16 x 16	36
	18 x 18	37
	20 x 20	37
	22x 22	42
	24 x 24	48
	10 x 22	36
AB	10 x 4	\$21
	10 x 6	21
	12 x 4	23
	12 x 6	23

Notes:

- * 2 HR Rating - NOT for wood structure.
- 1. Install per UL installation instructions.
- 2. Most diffuser installations require a Thermal Blanket.

Thermal Blankets

Size (w x h)	Price
30 x 30*	\$8

*For 24" x 24" Lay-in Diffuser

Model **AC** - Round Radiation Dampers

Note:

Model AC Round Dampers are actual size

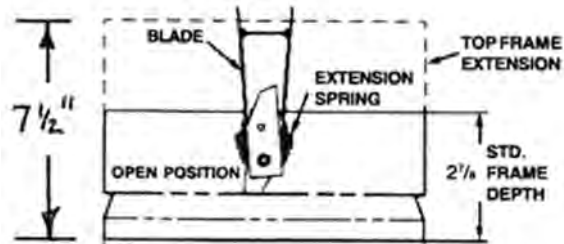

Model **AB** - Square and Rectangular Radiation Dampers

Note:

Model AB Square and Rectangular Dampers are ordered 1/4" under size

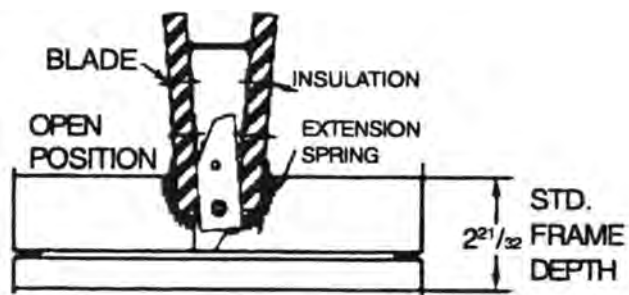

FIRE DAMPERS

PREFCO Model 5500 E-6 LPB

- Low-Pressure Drop “B” style Performance and “A” Style Mounting Simplicity
- Requires field fabricated sleeve
- Damper mounts within duct dimension

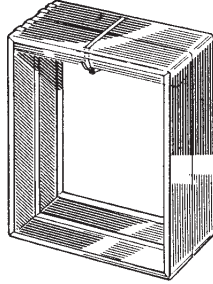

PREFCO Model 5500 E-8 M

- **Integral Sleeve Style** for up to 8” thick wall
- Low Pressure Drop “C” style performance
- Integral Sleeved Damper may be mounted with single angle ring
- Damper Size = DuctSize(WxH)+2

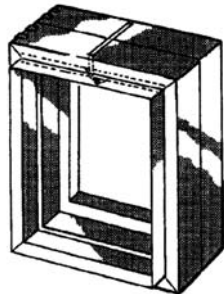

Duct Size	E-6 LPB	E-8 M
W x H	Price Each	Price Each
*6 x 6	*15	21
*8 x 6	*16	21
8 x 8	16	25
*10 x 6	*16	22
10 x 8	16	25
10 x 10	18	25
*12 x 6	*16	22
12 x 8	15	26
12 x 10	18	26
12 x 12	18	25
*14 x 6	*16	25
14 x 8	18	26
14 x 10	20	29
14 x 12	20	29
14 x 14	22	31
16 x 8	18	26
16 x 10	20	29
16 x 12	20	29
16 x 14	20	30
16 x 16	22	31

Duct Size	E-6 LPB	E-8 M
W x H	Price Each	Price Each
18 x 8	20	29
18 x 10	23	31
18 x 12	23	31
18 x 14	25	34
18 x 16	28	34
18 x 18	28	37
20 x 8	20	29
20 x 10	23	31
20 x 12	23	31
20 x 14	25	34
20 x 16	25	34
20 x 18	26	37
20 x 20	26	37
24 x 12	24	33
24 x 14	26	37
24 x 16	26	37
24 x 18	30	41
24 x 24	33	46
30 x 16	40	48
30 x 20	40	52

*Dampers 6” and less are Model 5650 single blade

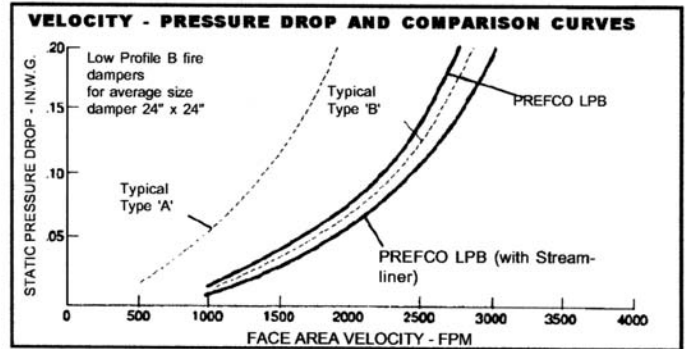

THE PREFCO ADVANTAGE

- All models are UL listed for single flange angle ring mounting – saves material and labor
- Model 5500 E-6 LPB’s provide “B Style Damper” low pressure drop without oversizing sleeves or wall opening



Don't see your size listed above? 1, 3, & 5-day quick ship available. Call for details.

SINGLE FLANGE MOUNTING OPTION

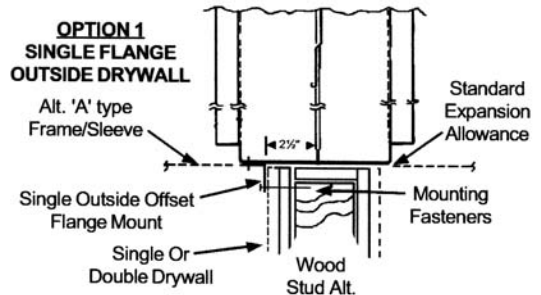

FIRE DAMPERS

PREFCO Model 5500E8 - CR - Integral Sleeved Round

- Low pressure, round inlet/outlet
- Vertical or horizontal application
- Install without additional sleeve per installation instruction sheet no. 5500-11-FS2
- Optional retaining angle kits and/or damper flats

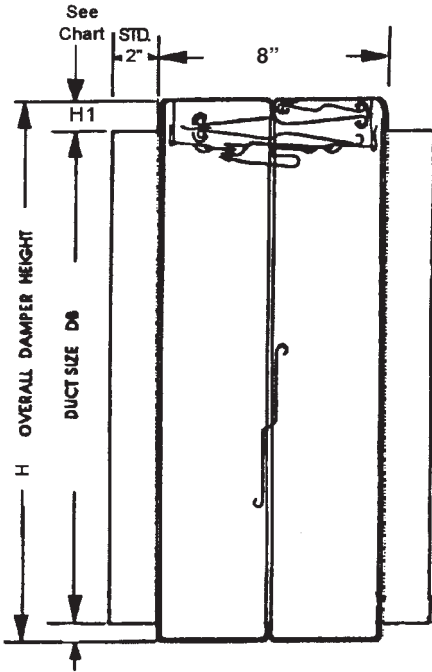
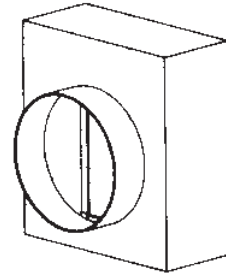

Round Size "DB"	Height "H"	Width "W"	Fire Damper Price Each	Damper Flats Price Each Set	Retaining Angle Price Each Set
6	8-1/2	8	\$31	10	11
8	10-1/2	10	35	11	12
10	12-1/2	12	40	12	13
12	14-1/2	14	40	13	14
14	16-1/2	16	50	15	16
16	18-1/2	18	50	15	16
18	20-1/2	20	62	19	19

Notes:

- 1) "DB" undersized 1/8"
- 2) "H" and "W" undersized 1/4"
- 3) Damper flats and retaining angles are sold as a set.
- 4) Flats and retaining angles can be sold as a mix match set.

Damper Mount Notes:

- 1) See page 28 for single flange mounting option

PREFCO Model 5600F - Round Fire Damper

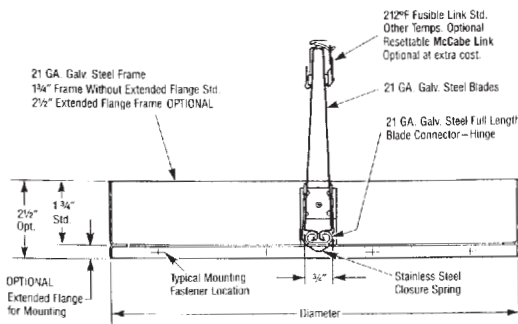

Size	Price Each
6	\$26
8	26
10	30
12	34
14	41
16	41

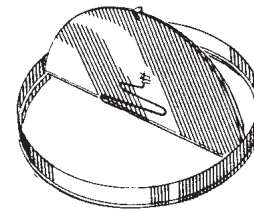

ADDITIONAL LINKS (Price Each)	
165°	\$3
212°	3